

Owner's Manual

N°33H
Monaural
Power Amplifier

Important Safety Instructions

1. Read these instructions.
2. Keep these instructions.
3. Heed all warnings.
4. Follow all instructions.
5. Do not use this apparatus near water.
6. Clean only with a dry cloth.
7. Do not block ventilation openings. Install in accordance with the manufacturer's instructions.
8. Do not install near any heat sources such as radiators, heat registers, stoves, or another apparatus that produces heat.
9. Do not defeat the safety purpose of the polarized or grounding-type plug. A polarized plug has two blades with one wider than the other. A grounding-type plug has two blades and a third grounding prong. The wide blade or third prong is provided for safety. If the provided plug does not fit into the outlet, consult an electrician for replacement of the obsolete outlet.
10. The MAINS cord is intended to be the safety disconnect device for this apparatus. Ready access to the MAINS cord shall be maintained at all times.
11. Protect the power cord from being walked on or pinched, particularly at plugs, convenience receptacles, or the point where it exits from the apparatus.
12. Only use attachments and accessories specified by the manufacturer.
13. Unplug this apparatus during lightning storms or when unused for long periods of time.
14. Refer all servicing to qualified service personnel. Servicing is required when the apparatus has been damaged in any way, such as when the power cord or plug has been damaged; liquid has been spilled or objects have fallen into the apparatus; or the apparatus has been exposed to rain or moisture, does not operate normally, or has been dropped.
15. Ventilation should not be impeded by covering the ventilation openings with items such as newspapers, table cloths, curtains, etc.
16. No naked flame sources, such as candles, should be placed on the apparatus.
17.  Terminals marked with this symbol may be considered HAZARDOUS LIVE and the external wiring connected to these terminals requires installation by an INSTRUCTED PERSON or the use of ready-made leads or cords.

Warning!

To reduce the risk of fire or electric shock, do not expose the apparatus to rain or moisture. Do not place objects containing liquid, such as vases, on this apparatus.

FCC Notice

This equipment has been tested and found to comply with the limits for a Class B digital device, pursuant to part 15 of the FCC Rules. These limits are designed to provide reasonable protection against harmful interference in a residential installation. This equipment generates, uses, and can radiate radio frequency energy and, if not installed and used in accordance with the instructions, may cause harmful interference to radio communications. However, there is no guarantee that interference will not occur in a particular installation. If this equipment does cause harmful interference to radio or television reception, which can be determined by turning the equipment off and on, the user is encouraged to try to correct the interference by one or more of the following measures:

- Reorient or relocate the receiving antenna.
- Increase the separation between the equipment and the receiver.
- Connect the equipment into an outlet on a circuit different from that to which the receiver is connected.
- Consult an authorized Mark Levinson dealer or an experienced radio/TV technician for help.

Caution!

Changes or modifications not expressly approved by the party responsible for compliance could void the users authority to operate the equipment.

ii

Canada

This Class B digital apparatus complies with Canadian ICES-003.

Cet appareil numérique de la classe B est conforme à la norme NMB-003 du Canada.



3 Oak Park
Bedford, MA 01730-1413 USA
Telephone: 781-280-0300
Fax: 781-280-0490
www.marklevinson.com

Customer Service
Telephone: 781-280-0300
Sales Fax: 781-280-0495
Service Fax: 781-280-0499

Product Shipments
16 Progress Road
Billerica, MA 01821-5730 USA

Part No. 070-630273 | Rev 3 | 02/05

“Mark Levinson” and the Mark Levinson logo are registered trademarks of Harman International Industries. U.S. patent numbers and other worldwide patents issued and pending.

“Madrigal Audio Laboratories” and the Madrigal Audio Laboratories logo are registered trademarks of Harman International Industries. U.S. patent numbers and other worldwide patents issued and pending.

©2005 Harman Specialty Group. All rights reserved.

This document should not be construed as a commitment on the part of Harman Specialty Group. The information it contains is subject to change without notice. Harman Specialty Group assumes no responsibility for errors that may appear within this document.

Documentation Conventions

This document contains general safety, installation, and operation instructions for the N°33H Power Amplifier. It is important to read this document before attempting to use these components. Pay particular attention to safety instructions.



Appears on the component to indicate the presence of uninsulated, dangerous voltages inside the enclosure – voltages that may be sufficient to constitute a risk of shock.



Appears on the component to indicate important operation and maintenance instructions included in the accompanying documentation.



Appears on the component to indicate compliance with the EMC (Electromagnetic Compatibility) and LVD (Low-voltage Directive) standards of the European Community.

iii

Warning!

Calls attention to a procedure, practice, condition, or the like that, if not correctly performed or adhered to, could result in personal injury or death.

Caution!

Calls attention to a procedure, practice, condition, or the like that, if not correctly performed or adhered to, could result in damage or destruction to part or all of the component.

Note

Calls attention to information that is essential to highlight.

Table of Contents

Unpacking2
Opening the Shipping Crate2
Moving the N°33H3
Product Registration3
Installation Considerations4
Placement4
Ventilation4
Power Requirements5
Warm-up & Break-in Period6
Continuous Operation6
Special Design Features7
Massive Power Supply7
AC Power Regeneration7
Fully Balanced Design8
True Voltage Source8
Extensive Protection8
Front Panel10
Rear Panel11
Linking15
Making Link Connections15
Constructing Link Communication Cables16
Creating a Slave Chain16
Link Controls19
Troubleshooting20
Care & Maintenance22
Specifications23
Dimensions24
Declaration of Conformity25
Notes26

Unpacking

Warning!

DO NOT attempt to lift or move the N°33H without adequate assistance. Failure to follow the procedures included in this owner's manual may result in personal injury and/or product damage.

The shipping weight of each N°33H Monaural Power Amplifier is approximately 220 pounds (100 kg). To avoid injury, handle the N°33H with extreme care. At least two strong people are required to unpack the N°33H amplifier from its shipping crate.

Two pair of knit, white gloves with special gripping surfaces on the palms and fingers are included with your new N°33H. Please wear these gloves when lifting and moving the amplifier.

When unpacking the N°33H:

- **DO** keep the N°33H shipping crate upright at all times, as indicated by the arrows on the outside of the crate. The N°33H shipping crate is modular in design to facilitate the unpacking process.
- **DO** save all screws and packing materials for possible future shipping needs.
- **DO** inspect the N°33H for signs of damage during shipment. If damage is discovered, contact an authorized Mark Levinson dealer for assistance making the appropriate claims.

Caution!

DO NOT attempt to lift the entire N°33H at one time, even with two people. Always lift one end ONLY, leaving the other end supported by the base of the shipping crate or the floor.

DO NOT try to lift the N°33H while bending at the waist. When lifting, keep your back straight and use your leg muscles to lift.

Opening the Shipping Crate

1. Carefully cut the nylon straps around the crate. Note that the straps may be under tension, causing them to snap outward when cut. To avoid personal injuries, keep your face and body as far as possible from the box when cutting each strap.
2. Remove the screws securing the top of the crate to the base.
3. Lift the top of the crate upward until it clears the top of the N°33H. Then set the top of the crate aside.

Moving the N°33H

4. Use a socket wrench to remove:
 - The four 9/16-inch hexagonal-head bolts that secure the N°33H to the base of the crate. These bolts attach directly to the bottom of the N°33H's feet and are accessible underneath the pallet on which the N°33H sits.
 - The two 9/16-inch hexagonal-head bolts that hold the retaining bar in place.

Please read and understand these instructions before attempting to move the N°33H from the shipping crate base.

Note:

Protect delicate floor surfaces before moving the N°33H off the crate and onto the floor.

1. Position two people at the front of the N°33H to support its weight; a third person may be needed to hold the base of the crate in place while the N°33H is moving.
2. When all people are in position, carefully slide the N°33H off of the crate's base and onto the floor.

As the front of the N°33H clears the front edge of the crate, the two people positioned at the front of the N°33H must begin to support its weight. To do this, use the "handle" built into the sculpted faceplate (located just above the Mark Levinson logo) or the front heat sinks.
3. Continue to slide the N°33H forward until its center section clears the front edge of the base. Then lower the front of the N°33H to the floor.

At this point, the floor should support the front of the N°33H and the base of the crate should support the rear.
4. Position two people at the rear of the N°33H; a third person may be needed to slide the base of the crate out from underneath the N°33H.
5. Grip the rear heat sinks. Then lift the rear of the N°33H, leaving the front supported by the floor.
6. When the rear of the N°33H is lifted, slide the base of the crate out from underneath the N°33H, then carefully lower the rear of the N°33H to the floor.

Product Registration

Please register your N°33H Monaural Power Amplifier within 15 days of purchase. Register online at www.marklevinson.com or complete and return the included product registration card. Retain the original, dated sales receipt as proof of warranty coverage.

Installation Considerations

The N°33H requires special care during installation to ensure optimal performance. Pay particular attention to the information included in this section.

Placement

Your Mark Levinson N°33H Monaural Power Amplifiers are specifically designed to stand on the floor, and must be used as free-standing units. In most installations, locating them near the loudspeakers is best. Obviously, this approach minimizes the length of the speaker wires and necessitates longer interconnecting cables from the preamplifier to the power amplifiers. The advantage to this strategy is that the interconnecting cables carry low-current signals which are more readily transmitted over distances with great accuracy than are the necessarily high current signals required by loudspeakers.

You should leave at least six inches (15 cm) of free space behind each N°33H so that the AC cord and connecting signal cables have sufficient room to bend without crimping or undue strain.

You should also position each amplifier for easy access to the rear panel power switch. This switch effectively disconnects the amplifier from the AC mains.

Caution!

Before moving the N°33H, make sure it is powered off with the rear panel power switch. Then, make sure the power cord is disconnected from the electrical outlet.

Ventilation

Your Mark Levinson N°33H power amplifier is designed to complement your listening room visually, with a tall and narrow frontal area that reduces the effective “footprint” and makes it far more presentable than would be the case with a more traditionally proportioned design. As a result, it can be more easily placed beside your loudspeakers. As freestanding units, the N°33H amplifiers normally will have no problem with ventilation. Please follow the precautions below.

- **DO** select a dry, well-ventilated location out of direct sunlight.
- **DO** ensure free air flow around the N°33H to allow for adequate heat dissipation through air circulation.
- **DO** keep the top plate and heat sinks free from obstructions that could reduce air circulation.
- **DO** use fans to increase air circulation if the N°33H is installed in an enclosed space.

- **DO NOT** place the N°33H on a thick rug or carpet or cover the N°33H with a cloth, as this might prevent proper cooling.
- **DO NOT** expose the N°33H to high temperatures, humidity, steam, smoke, dampness, or excessive dust. Avoid installing the N°33H near radiators and other heat-producing appliances.

Note

Each N°33H dissipates about 360 watts of heat energy when idle; it is normal and safe for it to run warm.

Power Requirements

When shipped, the N°33H is configured for 100V, 120V, 220V, 230V or 240V AC power operation at 50 or 60Hz based on the country for which it is manufactured. Before operating the N°33H, make sure the ~ac mains connector label indicates the correct operating voltage for the current location.

Caution!

Do not attempt to adjust the operating voltage. Consult an authorized Mark Levinson dealer if the operating voltage is incorrect or if the operating voltage must be changed for relocation purposes.

Be advised that different operating voltages may require the use of different power cords and/or attachment plugs. Contact an authorized Mark Levinson dealer for assistance.

Your Mark Levinson N°33H Monaural Power Amplifier is characterized by its remarkable ability to pass a musical signal with utter integrity, regardless of how demanding that signal and the loudspeakers used might be. When called upon to do so, the N°33H is capable of generating truly prodigious power levels into almost any speaker load, on either an instantaneous or a continuous basis.

Depending on the demands placed on the N°33H by your loudspeaker and your listening habits, it is possible for the quality and current capability of your electrical service to become the limiting factor in the performance of your system.

In this case, consider installing a dedicated AC circuit for your amplifiers. Contact a licensed electrician for assistance. If more than one AC circuit is providing power to the system, contact a licensed electrician to ensure that all components are operating with the same solid, low-impedance ground reference.

Note

Building regulations and electrical codes differ from location to location, making it impossible to anticipate the requirements of high-current AC circuits such as the N°33H. Contact a local, licensed electrician for information.

Warm-up & Break-in Period

Although the N°33H delivers superior performance from the first time it is powered on, this performance will continue to improve as various components “break in.” You should notice the greatest performance improvements within the first 25 to 50 hours of use. The amplifier should continue to improve in sound quality for approximately 300 hours.

After this initial period, performance will remain consistent unless power is disconnected, allowing the amplifier to cool down. (Power is considered disconnected when the N°33H is powered off with the rear panel ~ac mains relay switch or the power cord is disconnected from the electrical outlet; or an extended power failure or power outage occurs. Power is not disconnected when the N°33H is in standby.) When power is returned, the N°33H will require a brief warm-up period of about 2 minutes before the amplifier sound quality is at its best. (You will never have to repeat the full 300 hour break-in period.)

6

Continuous Operation

The N°33H should be unplugged during lightning storms and extended periods of non-use. Otherwise, it is designed for continuous operation. For best performance, make sure the power cord is connected to an electrical outlet at all times. During normal operation, do not use the rear panel ~ac mains relay switch to power off the N°33H. Instead, use the **standby button** to place the N°33H into standby, which allows the power amplifier to remain warmed-up to deliver optimal performance at all times.

Special Design Features

While the N°33H Monaural Power Amplifier is straightforward in everyday use, it includes several design features that are responsible for its outstanding performance. In particular, it defies the accepted wisdom that it is impossible to design a large, powerful amplifier that also has all the finesse of the finest smaller amplifiers.

Massive Power Supply

The N°33H features a 3.47 kVA low-noise toroidal transformer in a fully balanced power supply—a design that provides separate power supplies for the amplifier's inverting and non-inverting halves. In addition, each N°33H uses four 60,000 μ F low-ESR capacitors.

Heavy bus bars enhance the efficiency of power distribution within the amplifier and eliminate variances introduced by the wiring harnesses commonly found in even high-performance amplifiers. High-frequency power supply bypass is accomplished using individual PC boards that use 32 components of several different film types. The resulting uniformly low power supply impedance seen by various circuits within the N°33H lays the foundation for massive power and extraordinary finesse.

AC Power Regeneration

The detrimental sonic effects of noisy, unbalanced AC power supplies are widely known. Commercially available passive AC line conditioners provide some measure of AC power filtering and surge protection for line-level components such as preamplifiers and digital audio processors. However, these line conditioners cannot handle the large, instantaneous currents that power amplifiers require. In effect, the line conditioner becomes a bottleneck in the otherwise free flow of power through the amplifier and loudspeakers, greatly reducing the dynamic impact of the signal.

To avoid these performance bottlenecks, the N°33H uses built-in line conditioning techniques. When AC power is delivered to the N°33H, it is rectified, filtered, and regulated into positive and negative DC voltages. A portion of this DC power is used to drive an oscillator circuit that regenerates a pure 60 Hz sinewave. This sinewave is then used to power a separate power supply dedicated to all voltage gain stages. The dedicated power supply benefits from a truly balanced source as well as the total elimination of AC noise and fluctuations. As a result, the N°33H's critical voltage gain stages operate in a truly optimized environment, passing a musical signal with outstanding low-level resolution and detail.

Fully Balanced Design

A truly balanced input topology eliminates the need for an input buffer amplification stage, allowing the first stage differential amplifier to be driven directly by the source. Matched impedances are presented to the source and both signals travel through identical circuit paths.

Meticulous attention to the layout of the amplifier, including careful mirror-imaging of circuits to cancel magnetic fields, was essential to minimize magnetic field distortions that can occur with such a massive power delivery system. The input signal remains balanced, and rejection of common mode noise and distortion is achieved in the loudspeaker's voice coil.

True Voltage Source

The N°33H operates like a true voltage source—maintaining the appropriate voltage at a given time (based on signal demands) without particular regard for the current demands of the associated loudspeakers. Whether the loudspeakers require a 1 or 50-amp current, the N°33H will deliver.

Forty output transistors distributed throughout the four main heat sinks conduct and control the flow of power to the associated loudspeakers. Ten complementary pairs of output transistors are used in both the inverting and non-inverting output stages.

No known high-quality loudspeaker can continuously absorb the full power of the N°33H; but many loudspeakers require these extreme bursts of power on a short-term basis when reproducing music at realistic levels. The N°33H provides these short bursts without creating power supply sag or altering sonic performance. Its imperturbable nature is reflected in the authority and control with which it reproduces musical signals.

Extensive Protection

The N°33H is designed to shut down if it senses certain fault conditions that could cause damage to itself or associated loudspeakers. These fault conditions include:

- The presence of DC (direct current) at the output
- Sustained output current (≥ 40 amps), indicating a short-circuit across the outputs
- Over or under-voltage conditions at the ~ac mains connector
- Unsafe operating temperatures in a critical area within the amplifier.

When powered on or placed in standby, the N°33H will automatically power off—as if the rear panel power switch had been set to the off position—if a fault condition is detected. It will not power on again until the fault condition is corrected. To restore normal operation, remove the cause of the fault and power

cycle the amplifier with the **~ac mains relay switch** on the rear panel.

In addition, the AC input to each transformer is fused to protect against excessive current conditions such as driving shorted outputs. In-rush limiting prevents premature aging of power supply components during power-up, and switches to off-line once the power supply has been charged.

Finally, the N°33H incorporates a controlled clipping circuit that prevents output devices from saturating. The harsh high-frequency harmonics generated by hard-clipped output devices are avoided by the wave-shaping action of this controlled clip circuitry.

Front Panel

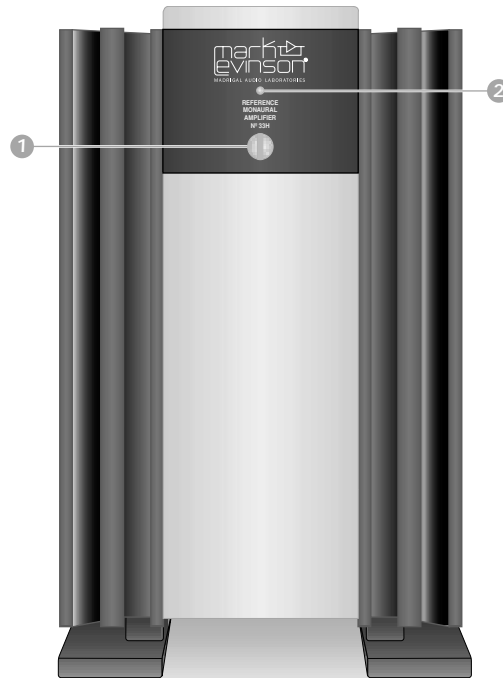

1. standby button

When power is first applied to the N°33H power amplifier, and assuming the rear panel AC mains switch is set to its on position, the amplifier remains completely off. Press the front panel **standby button** to bring the amplifier from completely off to standby. Each time you subsequently press the standby button (after a delay of ten seconds to allow all circuitry to stabilize), the N°33H is toggled between standby mode and fully on.

To turn the amplifier completely off, press and hold the **standby button** for approximately one second, until the front panel indicator light turns off.

2. indicator LED

Indicates the operating state of the N°33H.

LED Behavior	Description
Fully lit	Indicates that the N°33H is powered on.
Slowly blinking	Indicates that the N°33H is in standby.
Dimly lit	Indicates that the main power supply is off, and only the supervisory power supply operational.
Not lit	Indicates that the N°33H is powered off.

If the amplifier will not power on at all, check the rear panel **-ac mains relay switch**.

Rear Panel

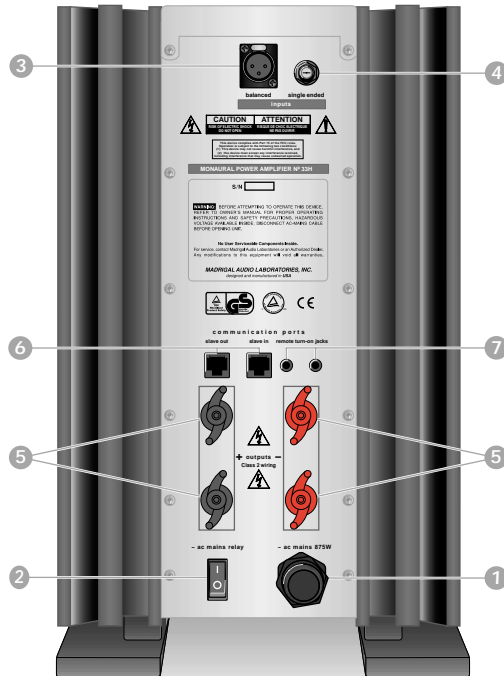

Caution!

Before making any connections, turn the master volume on the associated preamplifier all the way down, then power off the N°33H and all associated components and disconnect them from electrical outlets.

11

1. ~ac mains

Provides power to the N°33H when the power cord is connected to an electrical outlet. One high-current AC power cord is provided. This cord is specially designed to support potential current requirements when the N°33H is driving low-impedance loads.

Warning!

The N°33H has been safety-tested and designed for operation with a three-conductor power cord. Do not defeat the "third pin" or "earth ground" of the power cord.

Danger!

Dangerous voltages and current capabilities exist within the N°33H, even when the power cord is unplugged. There are no user-serviceable parts inside the amplifier. Refer all servicing to an authorized Mark Levinson dealer.

2. ~ac mains relay switch

The AC mains switch turns the amplifier completely off by disconnecting the supervisory power supply from the AC mains. Since this small supervisory supply controls the main power supply access to AC power, shutting down the supervisory power supply also disconnects the main supply from AC.

3. balanced input

Receives balanced audio input from the associated preamplifier. One XLR connector is available.

For best performance, use balanced connections whenever possible. Refer to the illustration below and to the associated preamplifier documentation to ensure that N°33H XLR input pin assignments correspond to the associated preamplifier XLR output pin assignments. If not, wire the cable so that the appropriate input pin connects to the appropriate output pin.

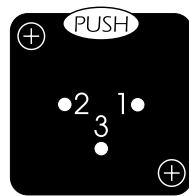

Pin 1: Signal ground

Pin 2: Signal + (non-inverting)

Pin 3: Signal - (inverting)

Connector ground lug: chassis ground

Note

Before making balanced connections, remove the U-shaped shorting-strap between pins 1 and 3 on the N°33H XLR input and save it for possible future use. This shorting-strap is installed when the N°33H is shipped.

4. single-ended input

Receives unbalanced audio input from a preamplifier with single-ended outputs. These signals are converted to balanced signals upon entering the chassis and processed as balanced signals thereafter. One RCA connector is available.

If the associated preamplifier does not support balanced connections, connect the RCA output on the preamplifier to the RCA input on the N°33H. To reduce the chance of noise at the (otherwise unterminated) inverting XLR input, insert the supplied U-shaped shorting strap between pins 1 and 3. (This shorting strap is installed when the N°33H is shipped.)

5. loudspeaker binding posts (outputs)

Provide audio output. Two pair of custom-made, gold-plated, high-current binding posts labeled + (positive) and - (negative) are included. Positive binding posts are red; negative binding posts are black.

These binding posts are designed to facilitate high pressure, high contact area connections without the use of tools such as nut drivers. A simple finger-tightening actually yields higher contact pressure than traditional hex binding posts. There is no need to exert unusual effort when tightening.

Caution!

NEVER connect power amplifier outputs to any component other than a loudspeaker.

NEVER short-circuit power amplifier outputs.

NEVER connect power amplifier outputs to another power amplifier's outputs.

For best performance, use high-quality loudspeaker cables with either spade or hook lugs.



Spade Lug



Hook Lug

- Connect the + (positive) binding posts on the N°33H to positive inputs on the associated loudspeaker.
- Connect the - (negative) binding posts on the N°33H to negative inputs on the associated loudspeaker.

Caution!

DO NOT OVERTIGHTEN the N°33H binding posts. Tight, high-contact pressure connections can be achieved with finger-tightening.

DO NOT FORCE the N°33H binding post “wings” up and over a bent or oversized connector. Doing so may result in binding post damage. If the connector obstructs “wing”-turning, slide it into place when the binding post opening provides a snug fit. Then, use quarter-turns to tighten the connection as needed.

6. slave in & slave out communication ports

Provide “links” to compatible Mark Levinson preamplifiers and power amplifiers, allowing the N°33H and linked preamplifiers or power amplifiers to share Link controls. Two 6-pin modular RJ-11 jacks labeled **slave in** and **slave out** are available.

The **slave in** communication port can be connected to a compatible Mark Levinson preamplifier that offers Link or **Link2** communication ports. The **slave out** communication ports can be connected to a compatible Mark Levinson power amplifier that offers Link or **Link2** communication ports.

Note

Refer to “Linking” BEFORE linking the N°33H to other Mark Levinson components.

7. remote turn-on jacks

Provide DC trigger control. One 1/8-inch (3.5mm) mini-jack is available to receive 5–12V DC signals from a connected component, and one 1/8-inch mini-jack is available to pass these signals along to a connected power amplifier. The illustration below shows tip polarity requirements.



Connect one of the **remote turn-on jacks** on the N°33H to the trigger out connector on a compatible component. Toggling the connected component between on and standby will toggle the N°33H into and out of standby.

Connect the other **remote turn-on jack** on the N°33H to the trigger in connector on a compatible power amplifier. The N°33H will pass DC signals along to the connected power amplifier, creating a “daisy-chain” of trigger control.

Note

The N°33H must be powered on with the -ac mains relay switch to respond to remote trigger commands.

Linking

Linking is available for all Mark Levinson components that offer Link or **Link2**™ communication ports, including **master**, **slave in**, **slave out**, **Link2**™, **Link2**™ **input**, and **Link2**™ **control** communication ports. These communication ports can be used to “link” compatible Mark Levinson components in a slave chain, allowing them to share Link controls.

The N°33H offers two Link communication ports labeled **slave in** and **slave out**. The **slave in** communication port can be connected to a compatible Mark Levinson preamplifier that offers Link or **Link2**™ communication ports. The **slave out** communication port can be connected to a compatible Mark Levinson power amplifier that offers Link or **Link2**™ communication ports.

The N°33H can be connected to the following Mark Levinson components:

- N°30 Series preamplifiers, including the N°32, N°38, and N°38S.
- N°300 Series preamplifiers, including the N°320S, N°326S, N°380, and N°380S.
- N°400 Series power amplifiers, including the N°431, N°432, N°434, and N°436.
- N°39 and N°390S CD Processors.
- Refer to the appropriate documentation for Link compatibility information about other Mark Levinson components.

Making Link Connections

- **DO** use Link or **Link2**™ communication ports, such as master, slave in, slave out, **Link2**™, **Link2**™ **input**, and **Link2**™ **control** communication ports.
- **DO** use supplied Link communication cables, which are provided in the accessory box.
- **DO** use constructed Link communication cables. Refer to “Constructing Link Communication Cables” for additional information.
- **DO NOT** use RS-232 ports or other rear panel connectors.

Caution!

Link connections must be made using Link or **Link2**™ communication ports and supplied or constructed Link communication cables. Connections made with other connectors or cables may damage the N°33H and other linked components, possibly voiding the manufacturer's warranty and/or standard repair policies.

Constructing Link Communication Cables

Link communication cables can be constructed using an 8-conductor modular telephone cable with the appropriate plug crimped on each end.

- Use an 8-pin RJ-45 plug when connecting to a preamplifier. RJ-45 plugs provide an 8-pin connection.
- Use a 6-pin RJ-11 plug when connecting to a power amplifier. RJ-11 plugs provide a 6-pin connection in which connector pins 7 and 8 are not used.

Note

BEFORE making Link connections, refer to the appropriate documentation for Link or **Link2™** communication port specifications for other Mark Levinson components.

When linking components with constructed Link communication cables, twist the cable 180° as shown in the illustration below for a straight-through (pin 1-to-pin 1) connection.

Note

Contact an authorized Mark Levinson dealer for additional assistance with making Link connections.

16

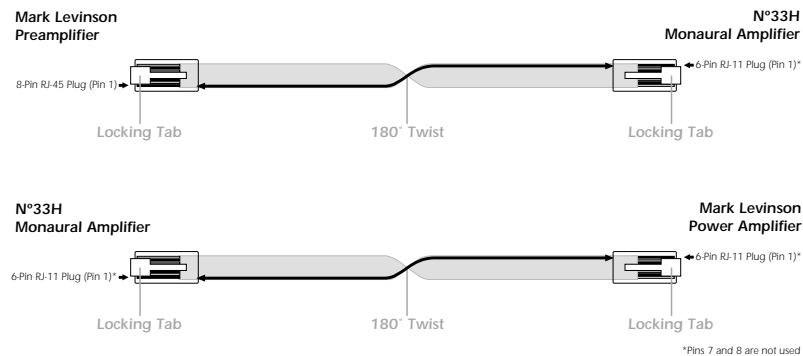

Creating a Slave Chain

Making Link connections creates a slave chain that facilitates communication among linked components, allowing them to share certain controls.

All slave chains:

- Must include compatible Mark Levinson components. The N°33H is compatible with the components listed on the previous page. Refer to the appropriate documentation for Link compatibility information about other Mark Levinson components.

- Must include components that are connected in a certain order to prevent communication from terminating. Power amplifiers such as the N°33H must be the last components in a slave chain.

Note

The slave chains in this section include preamplifiers and power amplifiers. However, slave chains can also include digital audio processors and digital transports. Refer to the appropriate documentation for information about including these Mark Levinson components in a slave chain.

The table below indicates slave chain requirements for preamplifiers and power amplifiers.

Component	Requirements & Connections
Preamplifier (e.g., N°320S)	<ul style="list-style-type: none"> • No maximum number per slave chain. • Connect the Link™ or slave out communication port on the preamplifier to the slave in communication port on the N°33H.
Power Amplifier (e.g., N°33H)	<ul style="list-style-type: none"> • Maximum of six per slave chain. • Connect the slave in communication port on the N°33H to the Link™ or slave out communication port on the preamplifier. • Connect up to six power amplifiers in a “daisy chain” using slave in/Link™ input-to-slave out/Link™ control communication port connections. The slave out/Link™ control communication port on the last power amplifier is not connected.

17

To create a slave chain that includes the N°33H:

1. Make sure the N°33H and all associated components are powered off.
2. Connect the **slave in** communication port on the N°33H to the **Link**™ or **slave out** communication port on the preamplifier.

If desired, connect the **slave out** communication port on the N°33H to the **slave in/ Link**™ **input** communication port on another power amplifier. Up to six power amplifiers can be included in a slave chain using “daisy chain” **slave in/ Link**™ **input-to-slave out/Link**™ **control** communication port connections. The **slave out/Link**™ **control** communication port on the last power amplifier is not connected.

Refer to the table above and to the illustration on the next page for additional assistance.

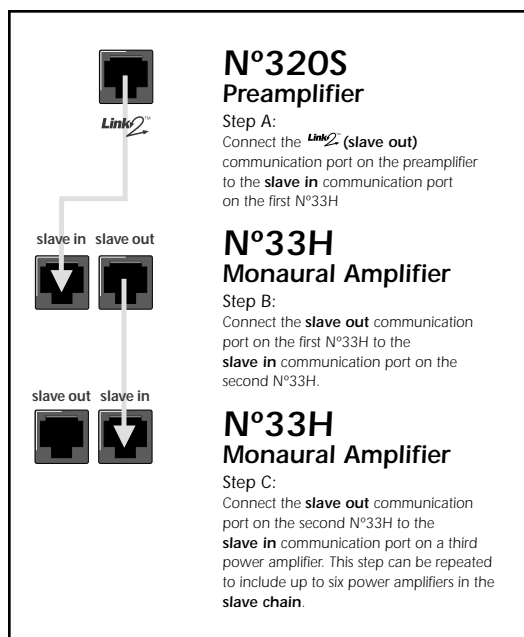

3. When Link connections have been made, power on linked components **ONE AT A TIME** in the order specified below. Allow each component to complete its initialization sequence before proceeding to the next component.
 - A. Digital Transports
 - B. Digital Audio Processors
 - C. Preamplifier
 - D. Power Amplifiers (begin with the first power amplifier in the slave chain)

At this point, the front panel standby LEDs on all linked components should be blinking in unison.

Note

Linked components must be powered on **ONE AT A TIME** in the specific order listed in step 3 (above) to ensure proper functioning of Link controls. **DO NOT** use a power strip switch to power on several components at once. When power is supplied to a strip, connected components that do not include a power button will automatically power on.

4. Take the linked preamplifier out of standby.
 - All linked power amplifiers should come out of standby as well. If this does not occur, repeat steps 3 and 4. If problems persist, contact an authorized Mark Levinson dealer.

Link Controls

Linking Mark Levinson components allows them to share certain controls. The table below provides a general description of controls the N°33H shares with other linked components. Some controls may not be available for certain component combinations. Other Mark Levinson components may share additional controls. Refer to the appropriate documentation for additional information.

Control \ Component	Preamplifier	Power Amplifier						
Standby Link	Placing the linked preamplifier into standby also places all linked power amplifiers into standby . Taking the linked preamplifier out of standby also takes all linked power amplifiers out of standby .	Placing a linked power amplifier into standby also places all other linked power amplifiers into standby . Taking a linked power amplifier out of standby also takes all other linked power amplifiers out of standby .						
Fault Condition Link	<p>If a linked power amplifier experiences a fault condition, it will report the fault condition to the linked preamplifier. If this occurs, the power amplifier number and fault condition code will appear on the preamplifier front panel display.</p> <p>The power amplifier number refers to its position in the slave chain. For example, AMP1 refers to the first power amplifier in the slave chain. Power amplifier fault condition codes are described in the table to the right.</p>	<table border="1"> <thead> <tr> <th>Code</th> <th>Description</th> </tr> </thead> <tbody> <tr> <td>HOT!</td> <td>Indicates a thermal fault condition</td> </tr> <tr> <td>DCO!</td> <td>Indicates a DC offset that cannot be corrected</td> </tr> </tbody> </table>	Code	Description	HOT!	Indicates a thermal fault condition	DCO!	Indicates a DC offset that cannot be corrected
Code	Description							
HOT!	Indicates a thermal fault condition							
DCO!	Indicates a DC offset that cannot be corrected							

Note the following:

- Linked components must be powered on **ONE AT A TIME** in the specific order listed in step 3 (previous page) to ensure proper functioning of Link controls.
- Link controls must be enabled on the linked digital transport linking menu, which allows activation and deactivation of individual Link controls. Refer to the appropriate digital transport owner's manual for additional information.
- Some Mark Levinson digital transports accommodate a maximum of four front panel display characters. In these cases, certain input names appear abbreviated on the front panel display. For example, an input named No320S will appear as No32 on the digital transport front panel display even though the input is associated with the N° 320S.
- The linked preamplifier and power amplifier(s) must be in the same **standby** state to allow the linked power amplifier(s) to enter **standby** after a power failure.

Troubleshooting

Incorrect operation is sometimes mistaken for malfunction. If problems occur, refer to this troubleshooting section. If problems persist, contact your Mark Levinson dealer.

1. No audio and the front panel indicator LED is not lit.

- Examine ~ac mains connections to ensure the power cord is connected to the electrical outlet.
- Make sure the N°33H is powered on with the rear panel **power switch**.
- Examine the electrical circuit breaker to ensure that power is supplied to the electrical outlet to which the N°33H is connected.
- A power loss or power outage may have occurred. In this case, power cycle the N°33H with the **power switch**, waiting at least 10 seconds between powering the N°33H off and on.
- A fuse may be blown inside the N°33H. In this case, disconnect the power cord from the electrical outlet. Then, contact an authorized Mark Levinson dealer. **Do not attempt to replace the fuse. There are no user-serviceable parts within the N°33H.**

Danger!

Potentially lethal voltages and current capabilities exist within the N°33H, even when the power is cord disconnected from the electrical outlet. **DO NOT attempt to open the amplifier's cabinet. There are no user-serviceable parts inside the amplifier. Refer all servicing to an authorized Mark Levinson dealer.**

2. No audio and the front panel indicator LED is dimly lit.

- A power loss or power outage may have occurred. In this case, power cycle the N°33H with the rear panel **power switch**, waiting at least 10 seconds between powering the N°33H off and on.

3. No audio and the front panel indicator LED is blinking slowly.

- The N°33H is in **standby**. To take it out of **standby**, press and release the **standby button**. The N°33H will power on.

Danger!

4. No audio and the front panel indicator LED is lit at full brightness.

- The N°33H is powered on, but is not passing a signal. Power the N°33H off with the **~ac mains relay switch**, then examine the signal cables to ensure a solid connection between the N°33H and the associated preamplifier and loudspeakers.

Power the N°33H off with the **~ac mains relay switch** before touching the loudspeaker wires.

5. The N°33H keeps powering off.

- A fault condition may be present at the input (for example, a DC signal from the preamplifier) or the output (for example, short-circuited loudspeaker wires). If this occurs:
 - a. Power the N°33H off with the rear panel **~ac mains relay switch**.
 - b. Disconnect the input signal and loudspeaker wires.
 - c. Wait 10 seconds.
 - d. Power the N°33H on with the **~ac mains relay switch**.

If the N°33H powers on without entering **standby**, a fault condition is present at the input or the output. To isolate the problem:

- a. Power the N°33H off with the **~ac mains relay switch**.
- b. Reconnect the loudspeaker wires.
- c. Power the N°33H on with the **~ac mains relay switch**.

If the N°33H powers on into **standby**, the fault condition is present at the input. If not, the fault condition is present at the output.

6. If all else fails...

- Power cycle the N°33H with the rear panel **~ac mains relay switch**, waiting at least 10 seconds between powering the N°33H off and on.
- Contact an authorized Mark Levinson dealer.

Care & Maintenance

To remove dust from the cabinet of your N°33H, use a feather duster or a lint-free soft cloth. To remove dirt and fingerprints:

1. Dampen a soft, lint-free cloth with isopropyl alcohol, then lightly clean the surface of the unit with the cloth, moving with the “grain” of the anodized, brushed aluminum.

Do not use excessive amounts of alcohol that could drip off the cloth and into the unit.

2. Following the cleaning with alcohol, dampen a clean cloth with water and wipe over the surface you just cleaned with alcohol. This removes the alcohol residue.

Caution!

Never apply liquid cleaners directly to the N°33H. The direct application of liquids can result in damage to electronic components inside the unit.

Specifications

The correlation between published specifications and performance is unreliable. Measurements of your amplifier yield excellent results by any standards. However, only those specifications that apply to its actual operation are included here.

All specifications are subject to change at any time.

- Rated power output:**
- 34.6 Vrms (150 W) @ 8Ω
 - 34.6 Vrms (300 W) @ 4Ω
- All of the above power ratings were measured as continuous (rms) power from 20Hz–20kHz with no more than 0.3% THD.*
- Frequency response:**
- Within 0.2 dB from 20Hz to 20kHz
- Signal-to-Noise ratio:**
- –75 dB CCIR
- Input impedance:**
- 100kΩ (balanced)
 - 50kΩ (unbalanced)
- Voltage gain:**
- 26.8 dB
- Input sensitivity:**
- 1.59V (full-rated output)
- Power consumption:**
- 360W in idle; 130W in standby
- Mains voltage:**
- Determined by the requirements of the country for which the unit was manufactured; cannot be reset by dealer or user
- Overall dimensions:**
- See “Dimensions”
- Shipping weight:**
- 220 pounds (100 kg)
- Connector complement:**
- Four custom binding posts
 - One 3-pin XLR balanced input connector
 - One RCA input connector
 - Two 1/8" mini-jacks for remote turn-on
 - Two Mark Levinson communications ports on RJ-11
 - One captive high-current AC receptacle
- Output impedance:**
- Less than 0.05Ω from 20–20,000Hz

Dimensions



24

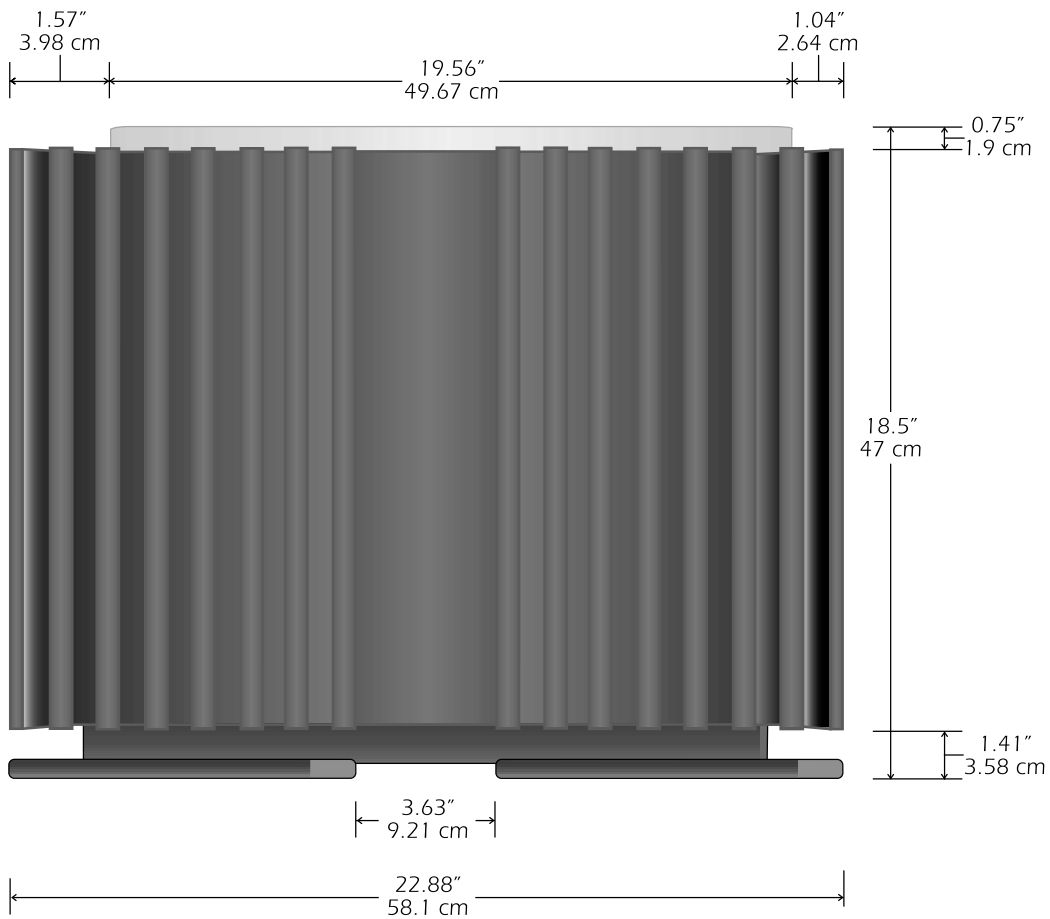

Declaration of Conformity

Application of Council Directive(s):

89/336/EEC and 73/23/EEC, as amended.

Standard(s) to which Conformity is Declared:

- EN 55013 : 2001
- EN 55020 : 2002
- EN 60065 : 1998
- EN 61000-3-2 : 2000
- EN 61000-3-3 : 1995 + A1 : 2001

Manufacturer:

Harman Specialty Group
3 Oak Park
Bedford, MA 01730-1413 USA

The equipment identified here conforms to the Directive(s) and Standard(s) specified above.

25

Type of Equipment:

Monaural Power Amplifier

Models:

Mark Levinson N°33H

Date:

January 2005

Harman Specialty Group
Vice President of Engineering
3 Oak Park
Bedford, MA 01730-1413 USA
Telephone: 781-280-0300
Fax: 781-280-0490
www.harman-specialtygroup.com



3 Oak Park, Bedford, MA, 01730-1413 USA | Telephone: 781-280-0300 | Fax: 781-280-0490 | www.marklevinson.com

Customer Support: Telephone: 781-280-0300 | Sales Fax: 781-280-0495 | Service Fax: 781-280-0499

Product Shipments: 16 Progress Road, Billerica, MA 01821-5730 USA

Part No. 070-630273 | Rev 3 | 02/05